

MODEL# 3500

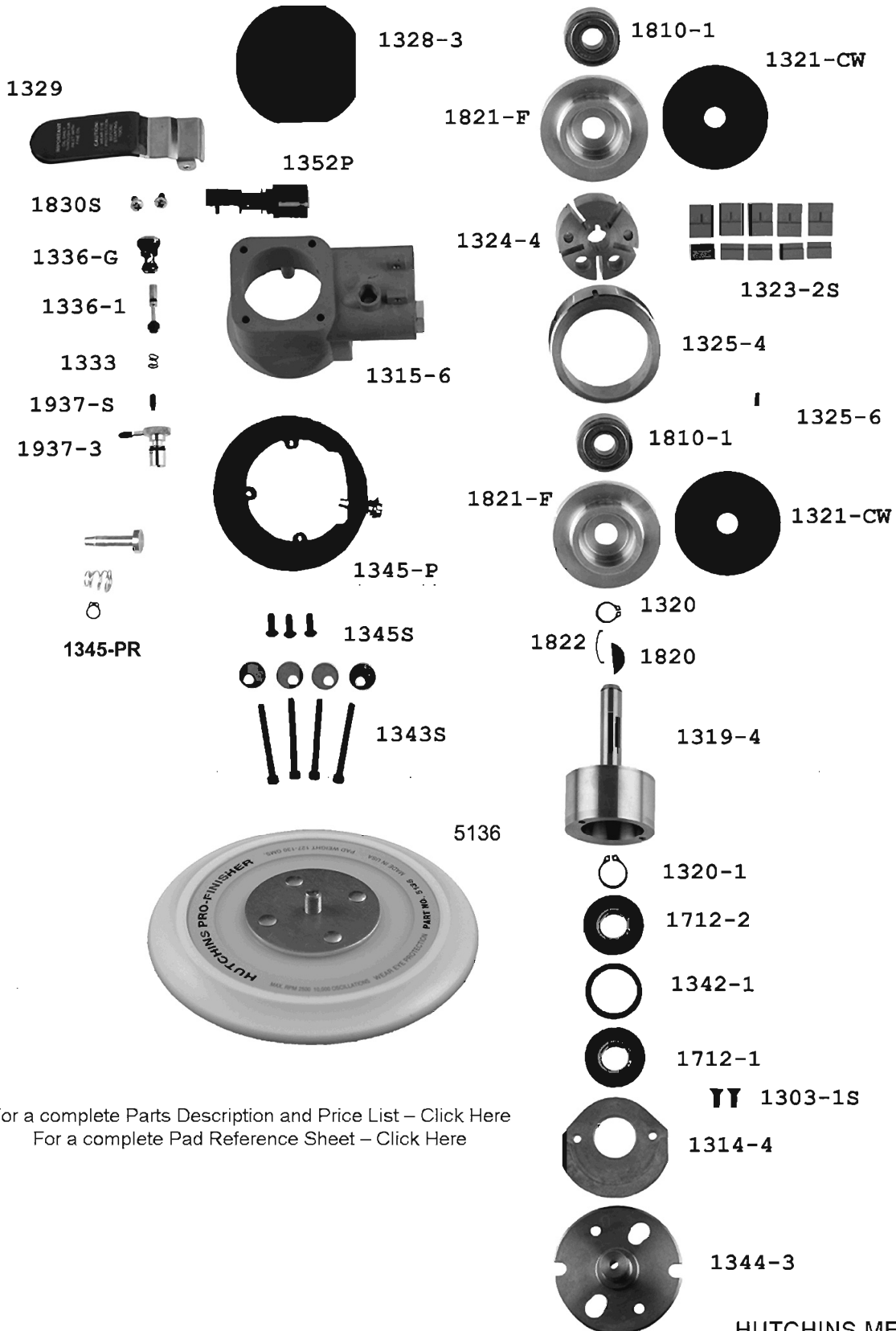

For a complete Parts Description and Price List – [Click Here](#)
 For a complete Pad Reference Sheet – [Click Here](#)